

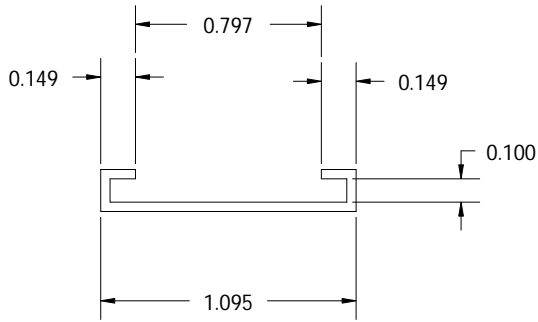

C-CHANNEL STOCK TOOLS

920-467-2477

jifram.com



H-139

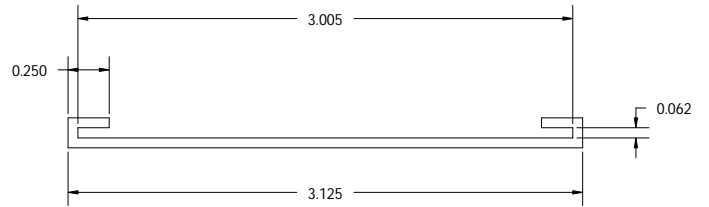

H-140

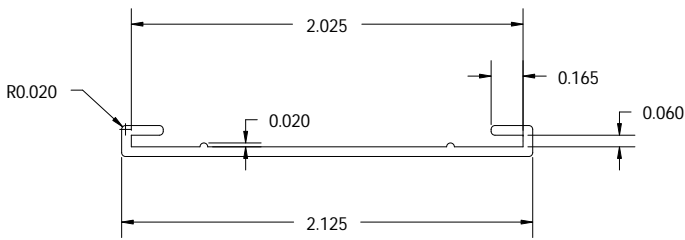

H-141

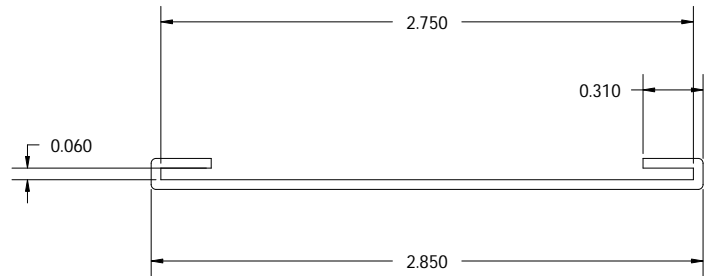

H-142

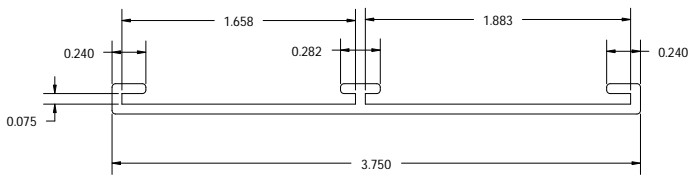

H-143

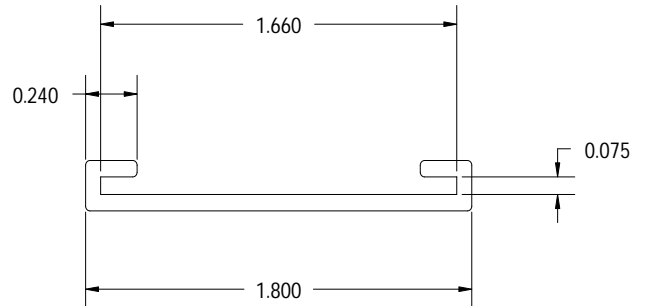

H-144

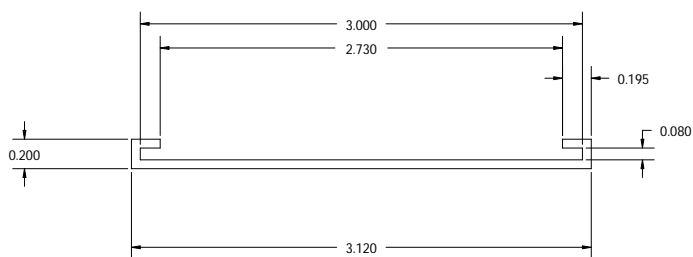

H-145

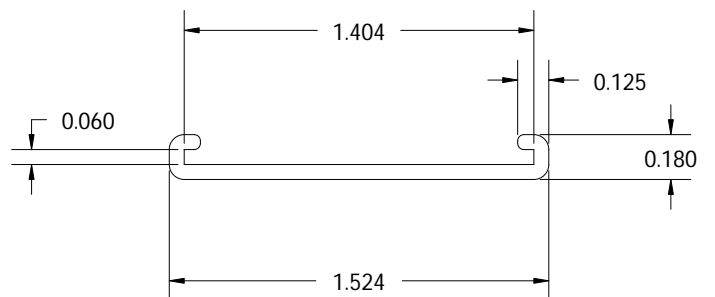

H-146



C-CHANNEL STOCK TOOLS (P.2)

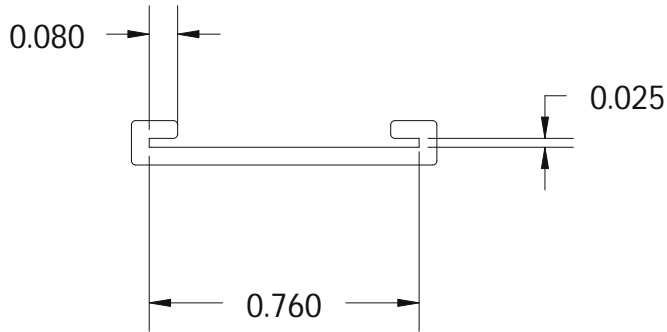

H-147

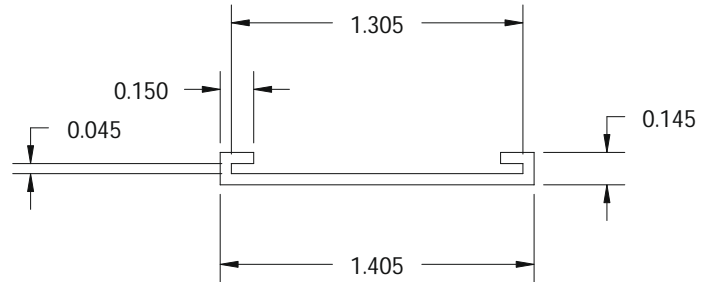

H-161

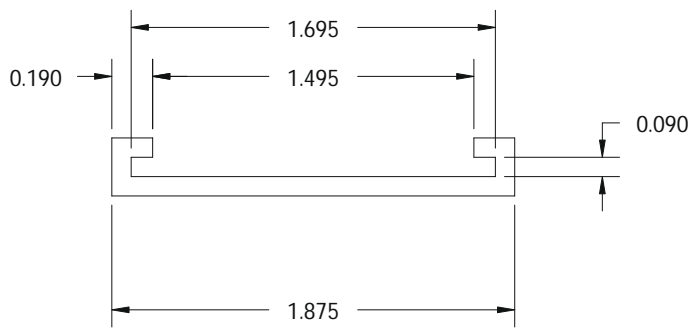

H-162

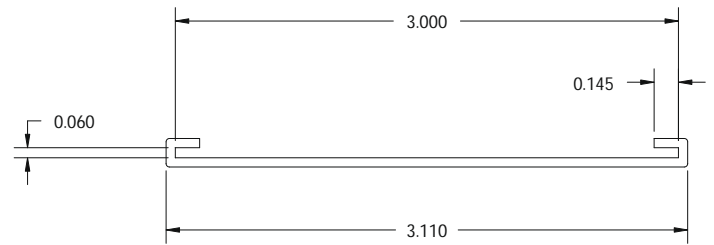

H-163

.090 WALL THICKNESS RPVC

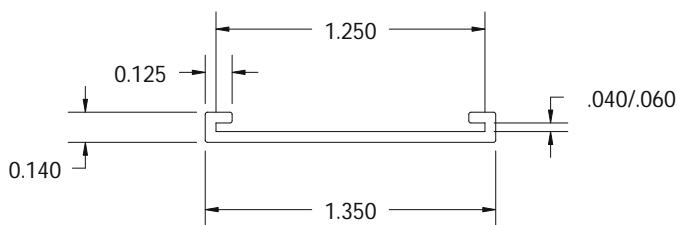

H-166

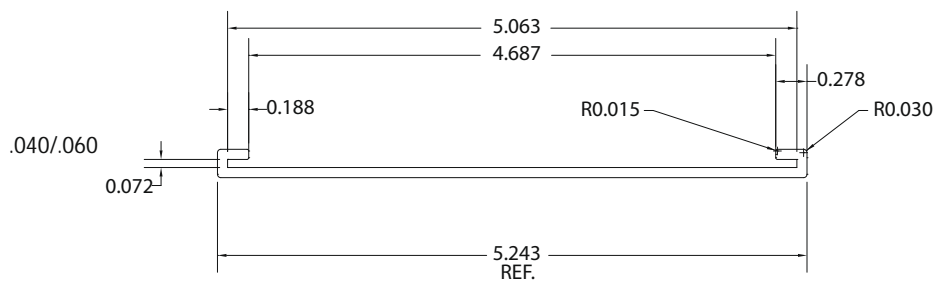

H-177

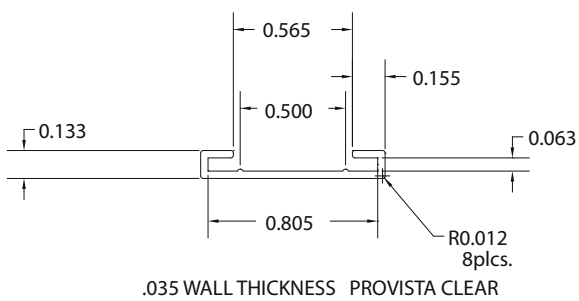

H-178

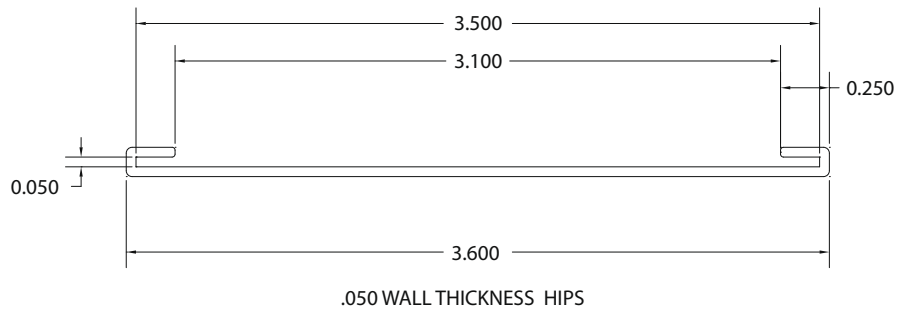

H-179



C-CHANNEL STOCK TOOLS (P.3)

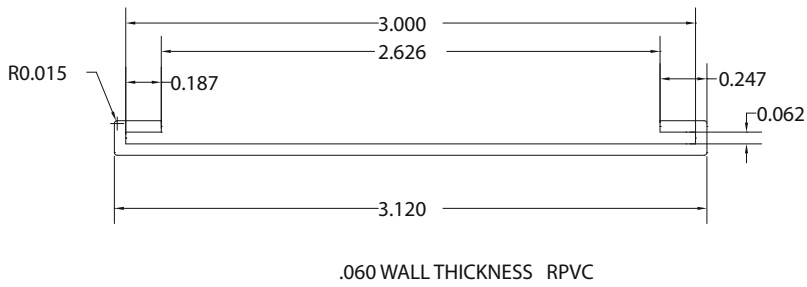

H-180

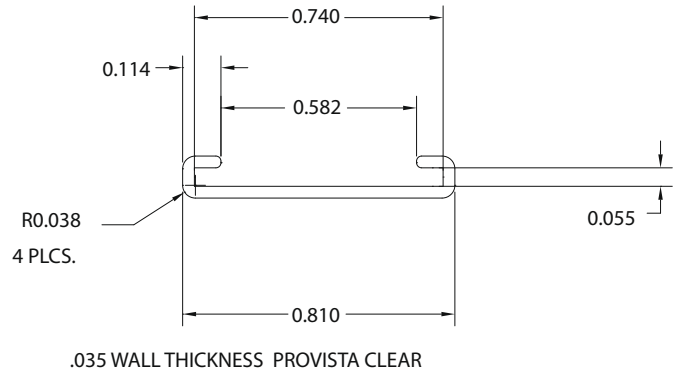

H-181

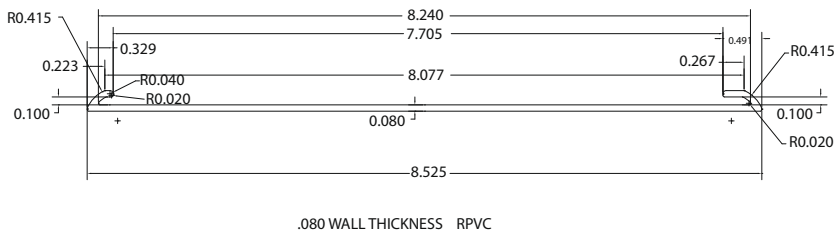

H-182

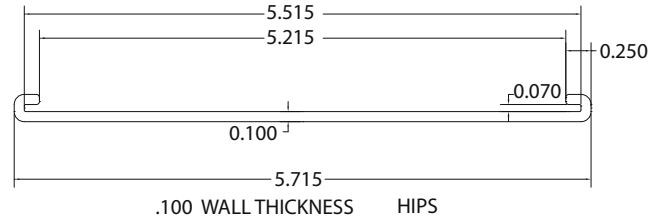

H-183

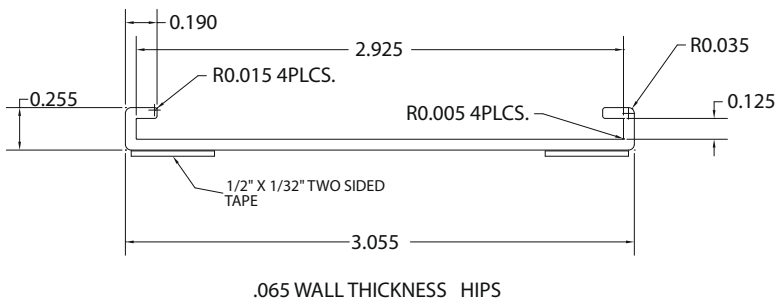

H-184

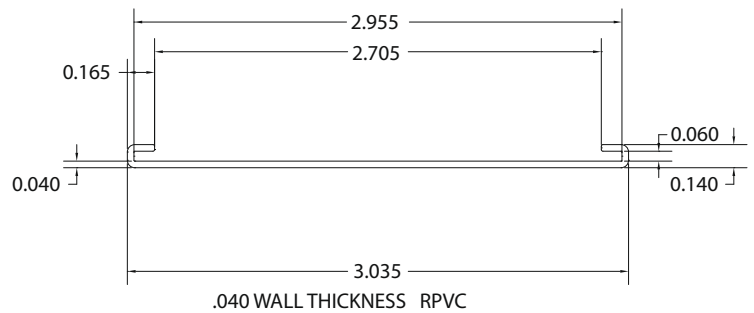

H-185

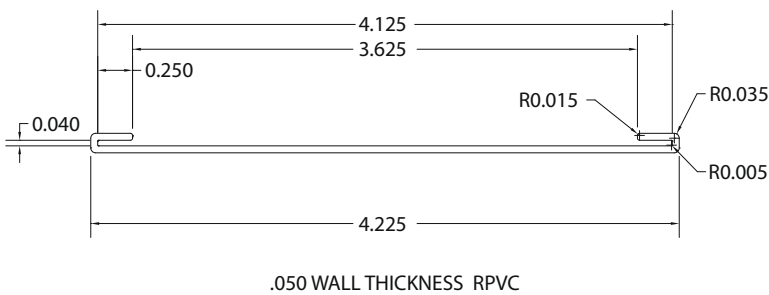

H-186

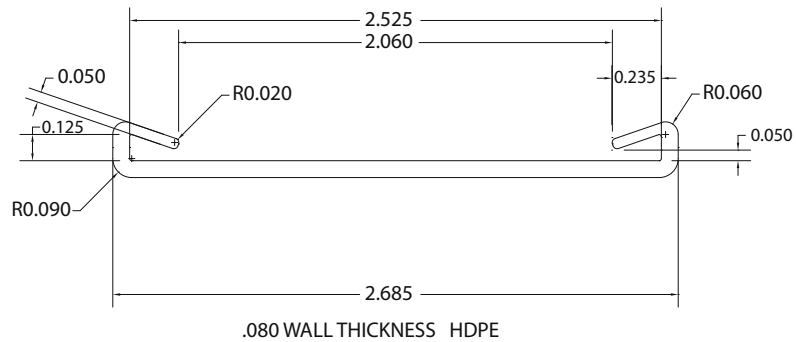

H-187



C-CHANNEL STOCK TOOLS (P.4)

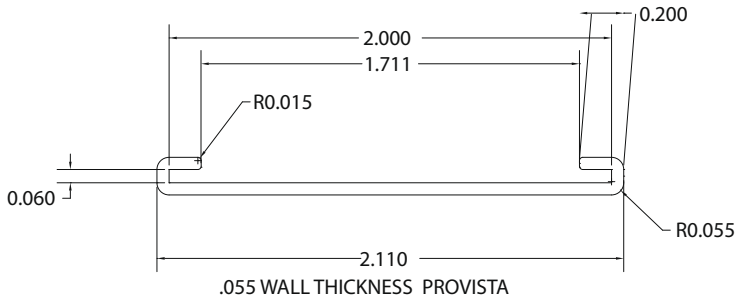

H-188

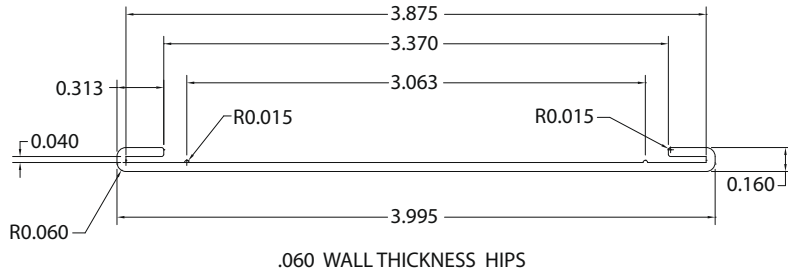

H-189

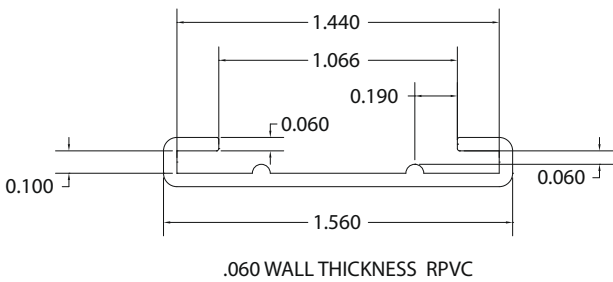

H-190

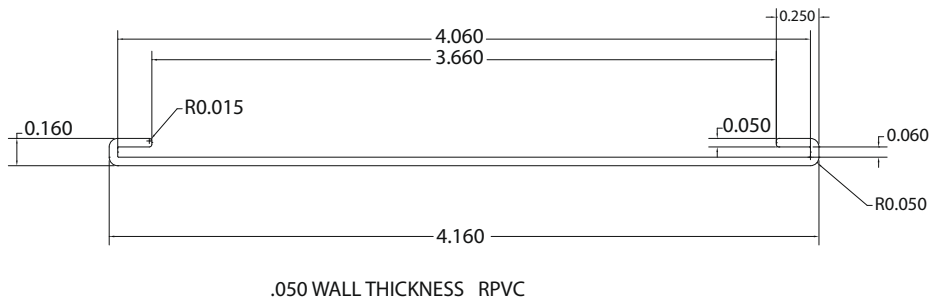

H-191

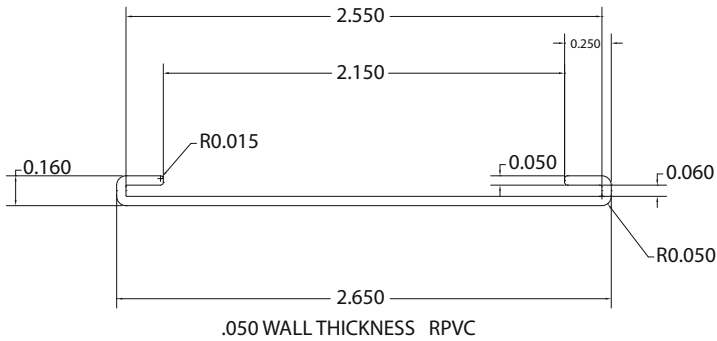

H-192

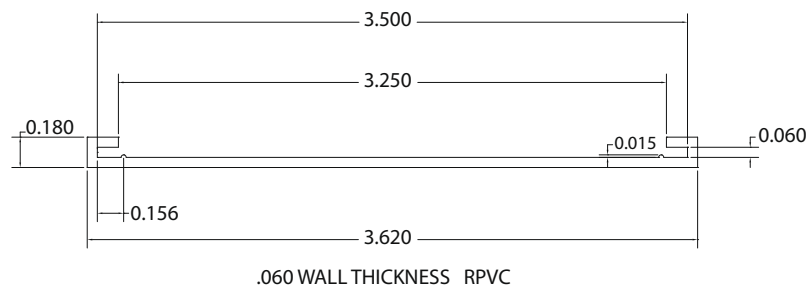

H-193

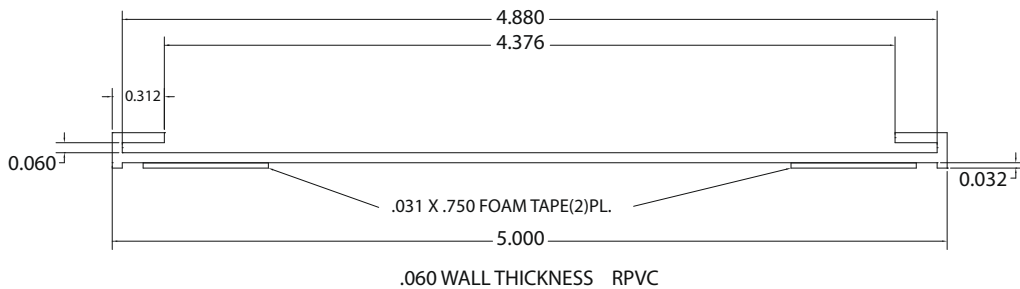

H-194

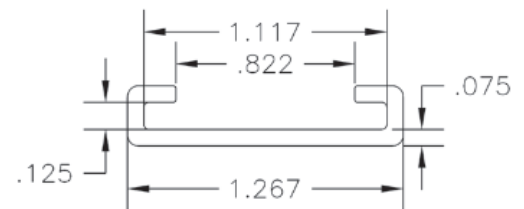

H-249



C-CHANNEL STOCK TOOLS (P.5)

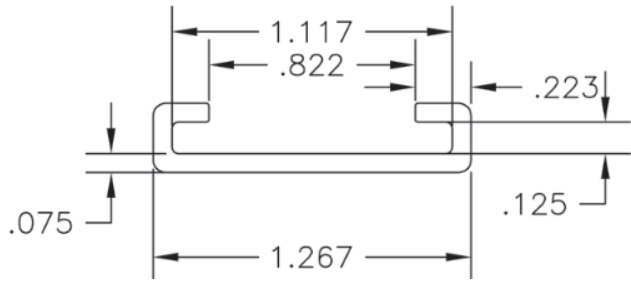

H-251

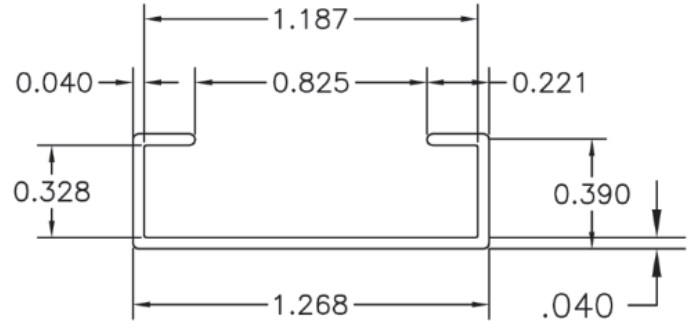

H-252

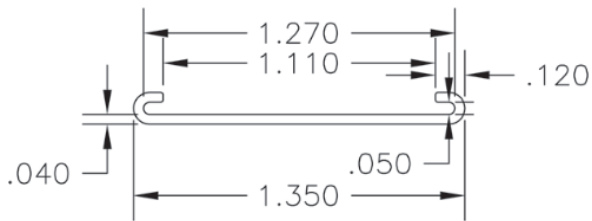

H-253

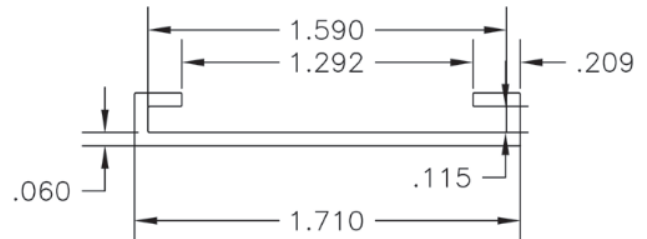

H-254

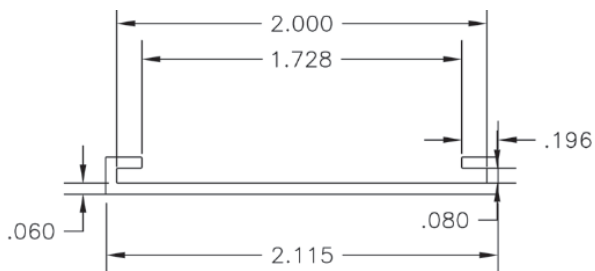

H-255

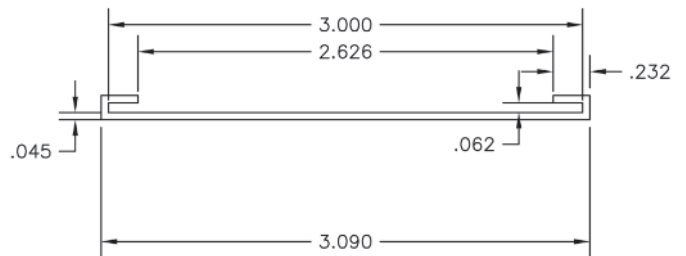

H-256

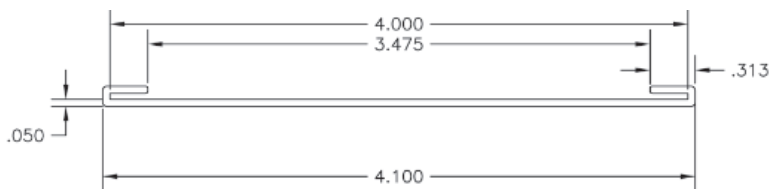

H-257

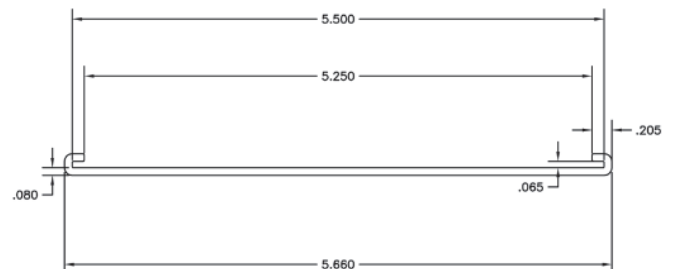

H-258



C-CHANNEL STOCK TOOLS (P.6)

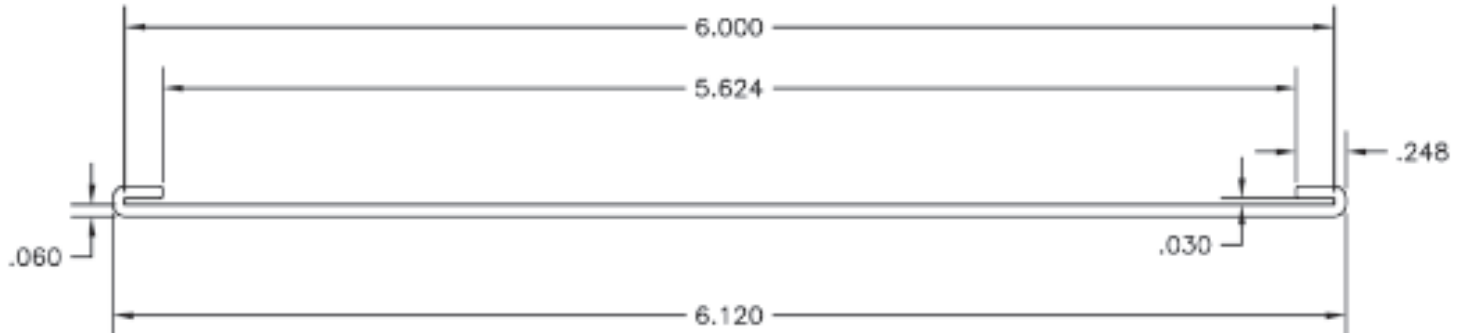

H-259

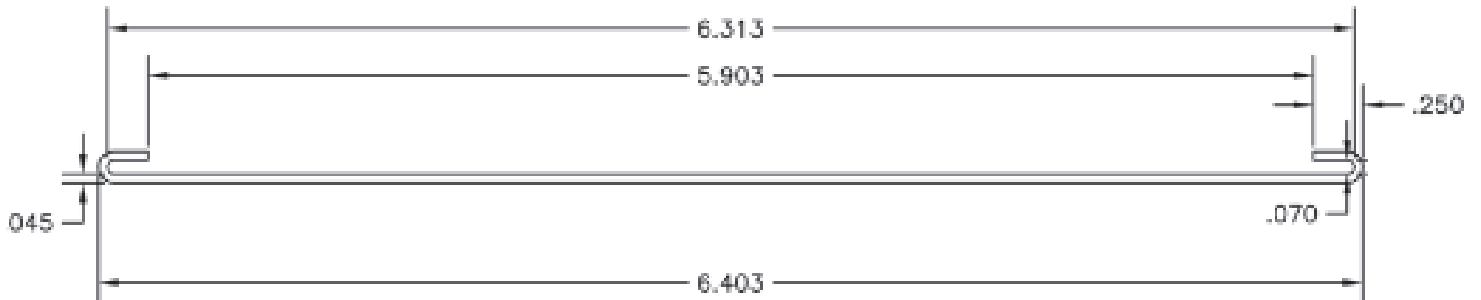

H-260

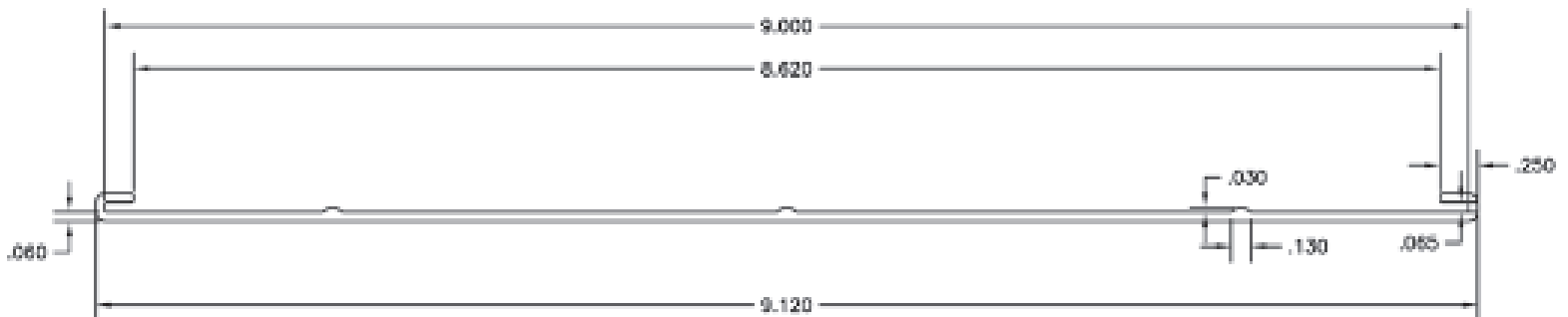

H-261