

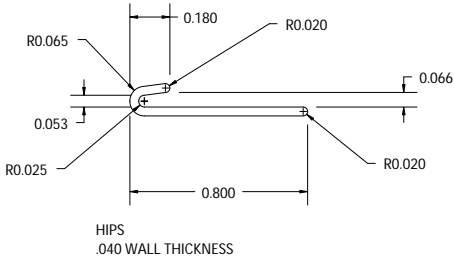

J-CHANNEL STOCK TOOLS

920-467-2477

jifram.com



H-100

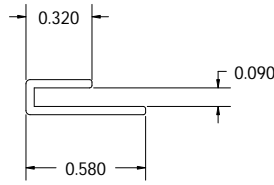

H-101

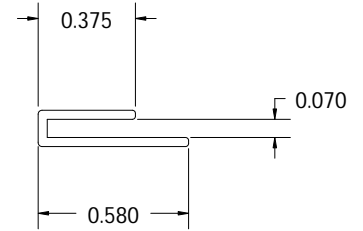

H102

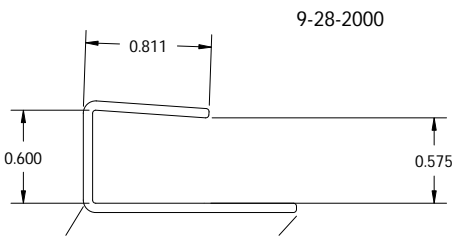

H-105

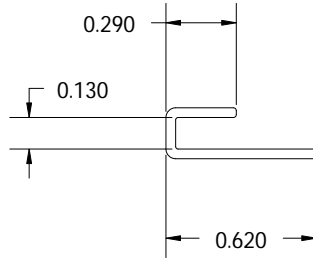

H-106

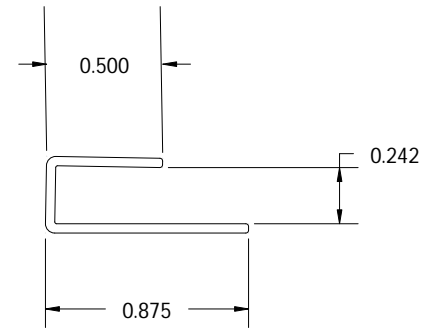

H-107

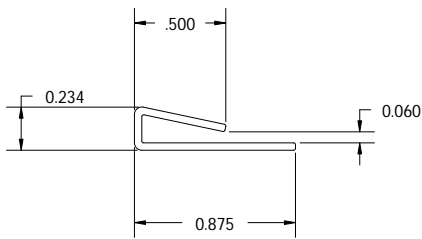

H-108

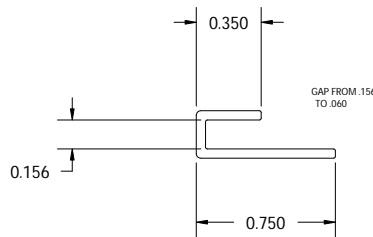

H-109

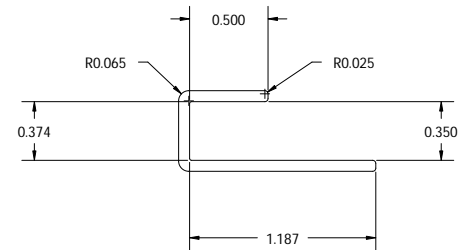

H-110

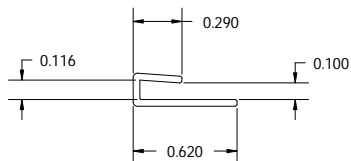

H-111

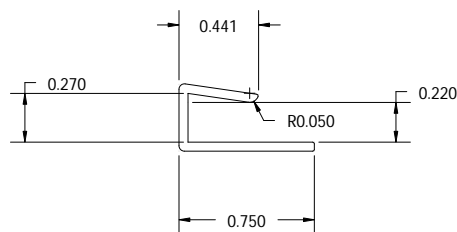

H-112

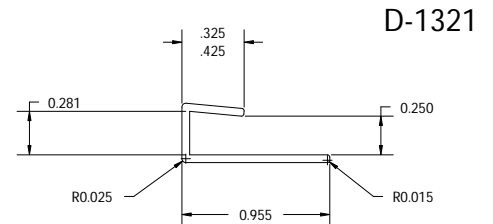

H-113

D-1321



J-CHANNEL STOCK TOOLS (P.2)

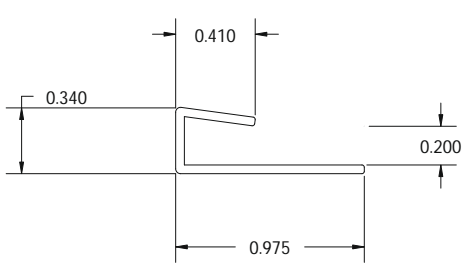

H-114

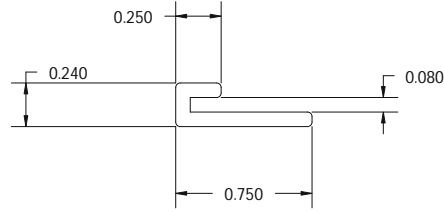

H-115

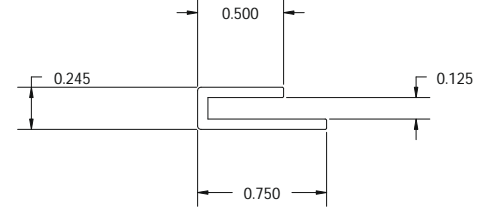

H-116

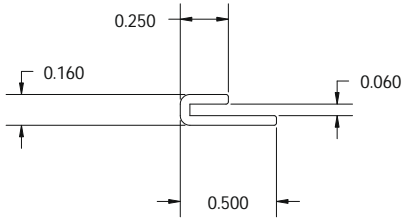

H-117

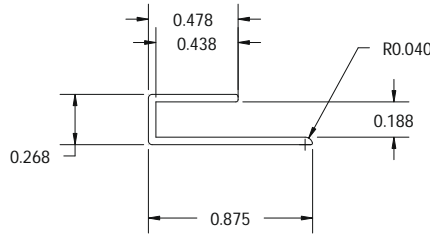

H-118

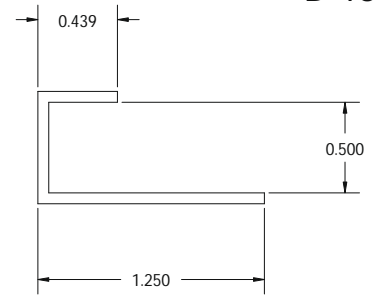

H-119

D-1309

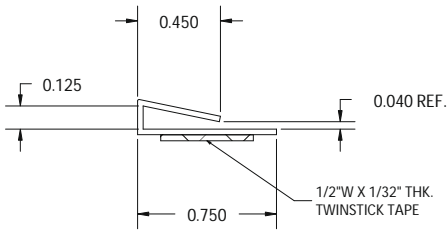

H-120

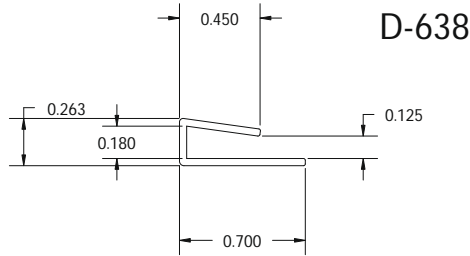

H-121

D-638

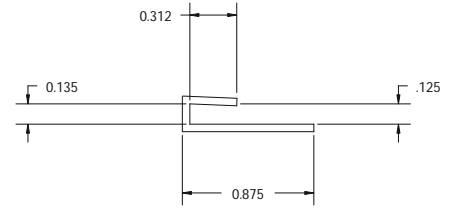

H-122

D-1074R

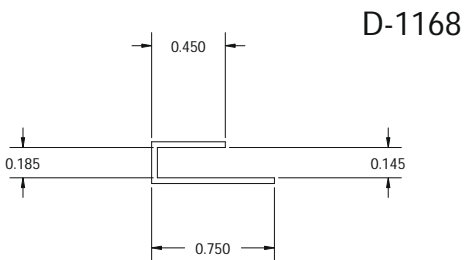

H-123

D-1168

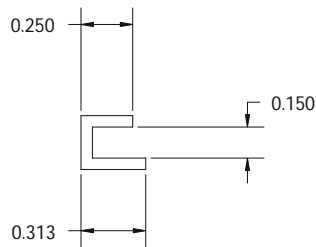

H-124

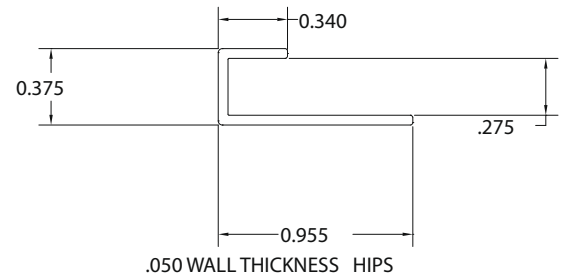

H-195



J-CHANNEL STOCK TOOLS (P.3)

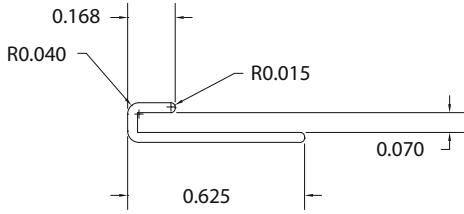

.035 WALL THICKNESS PROVISTA

H-196

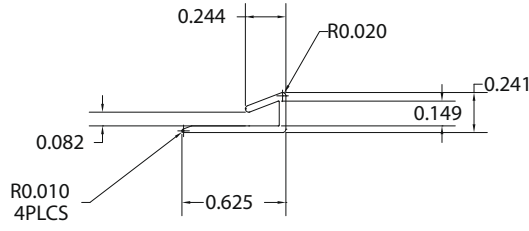

.040 WALL THICKNESS HIPS

H-197

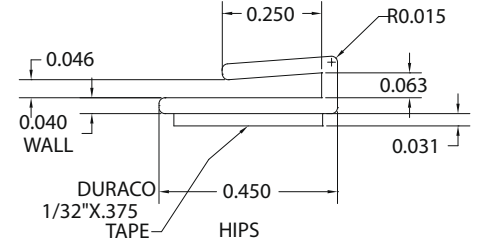

H-198

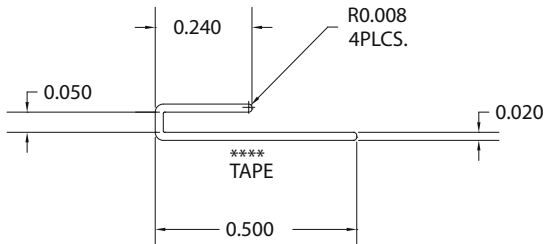

.020 WALL THICKNESS TRANSPARENT RPVC

H-199

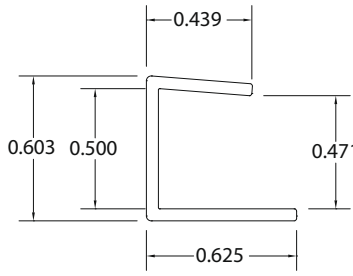

.050 WALL THICKNESS ABS

H-200

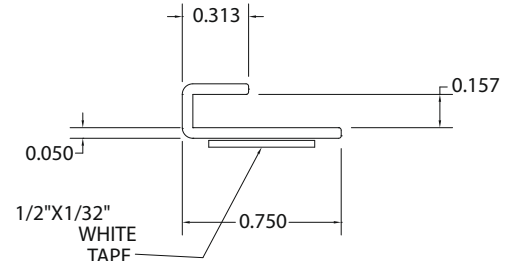

.050 WALL THICKNESS HIPS

H-201

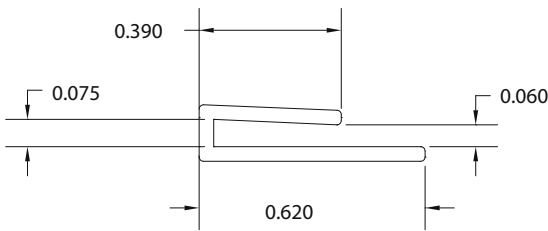

.040 WALL THICKNESS HIPS

H-202

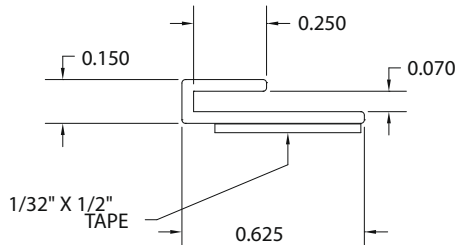

.045 WALL THICKNESS PROVISTA

H-203

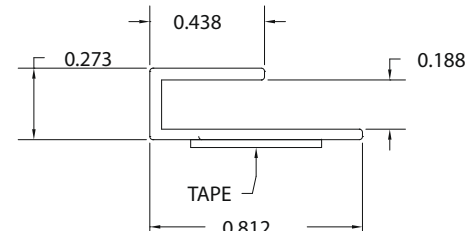

.045 WALL THICKNESS HIPS

H-204

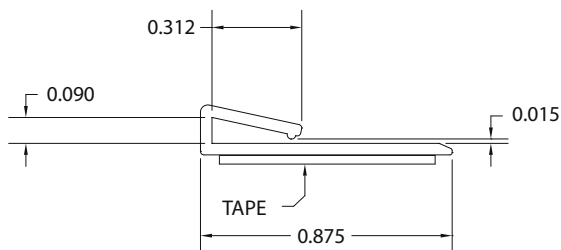

.050 WALL THICKNESS HIPS

H-205

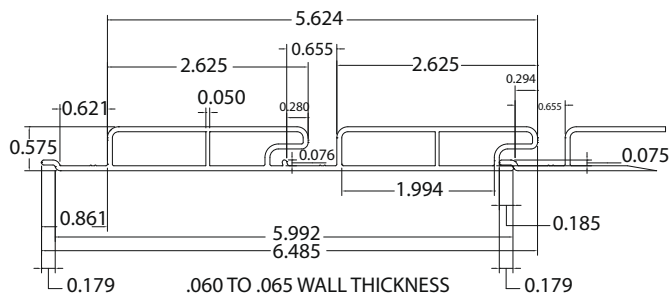

.060 TO .065 WALL THICKNESS

H-248



J-CHANNEL STOCK TOOLS (P.4)

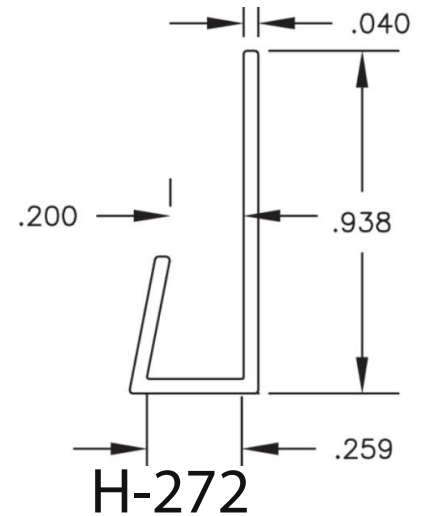
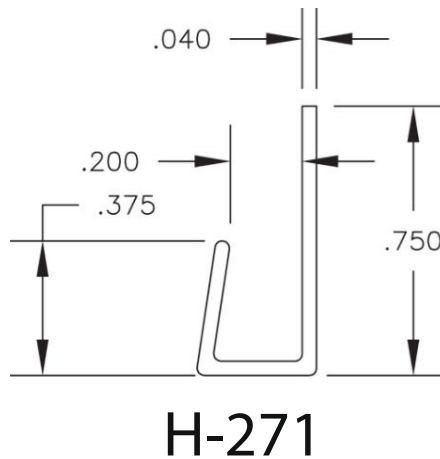
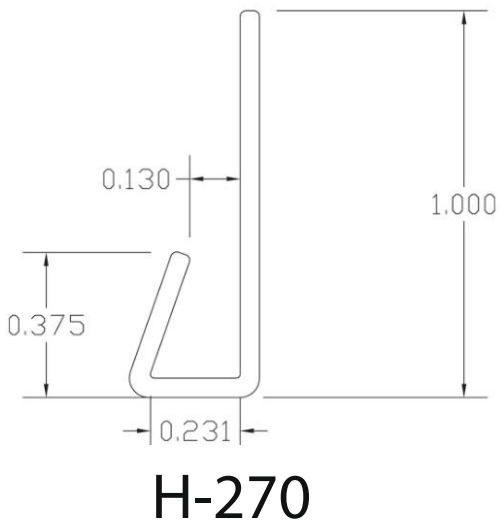
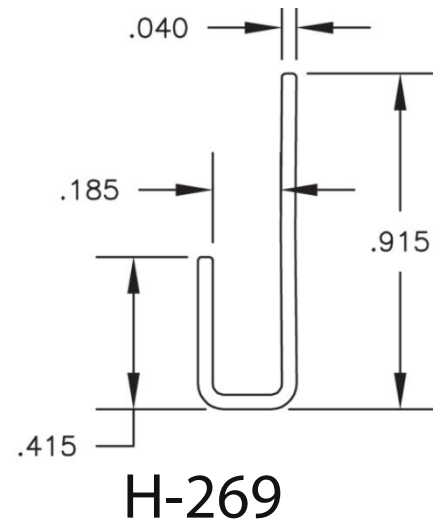
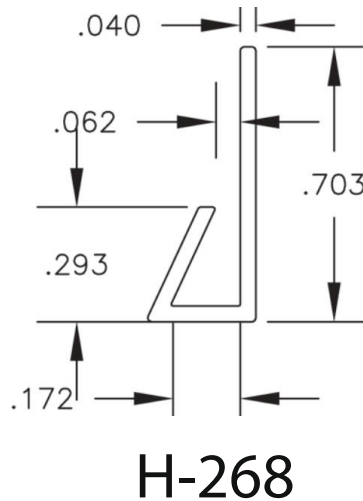
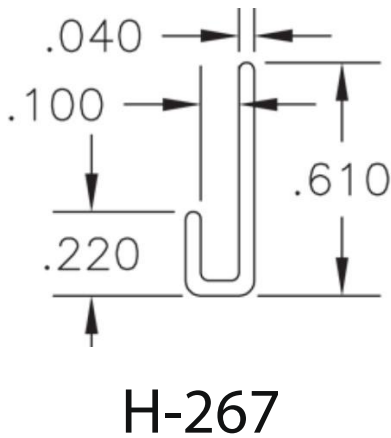
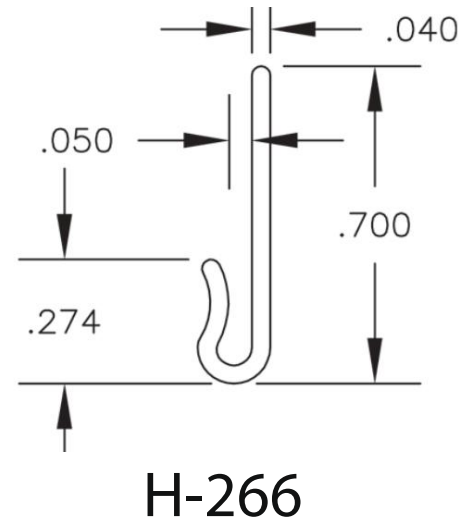
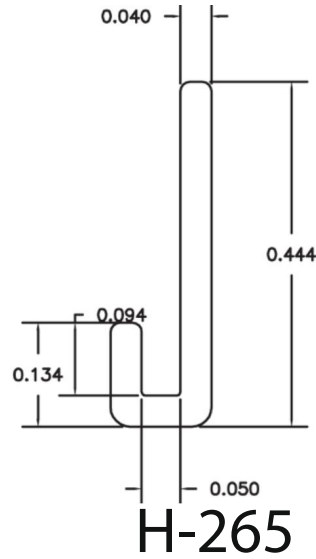
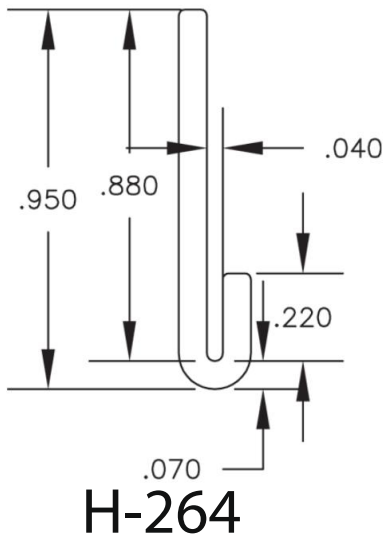



J-CHANNEL STOCK TOOLS (P.5)

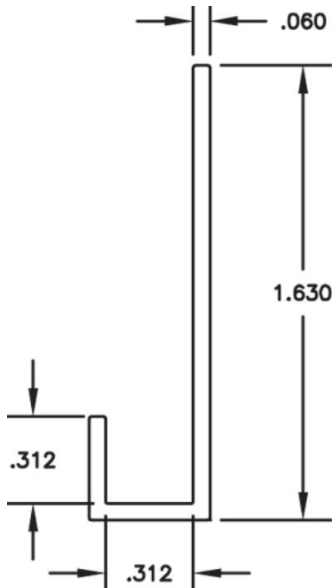

H-273

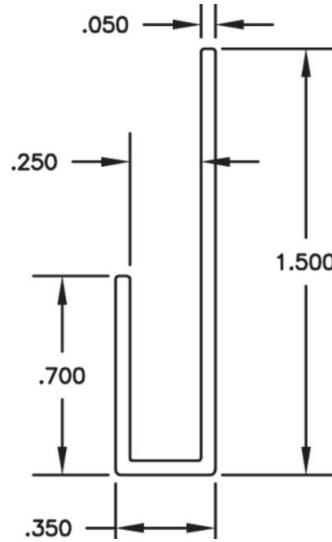

H-274

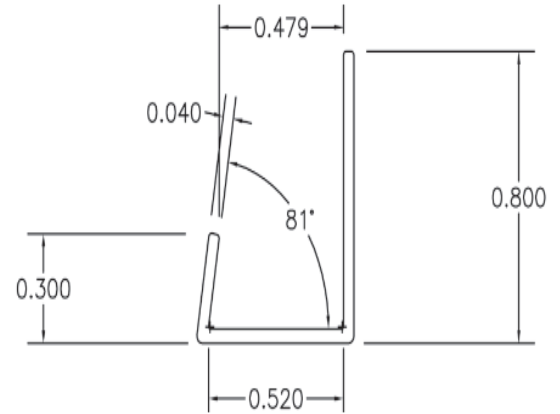

H-275

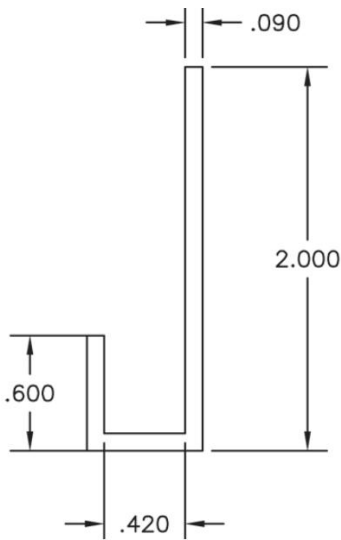

H-276

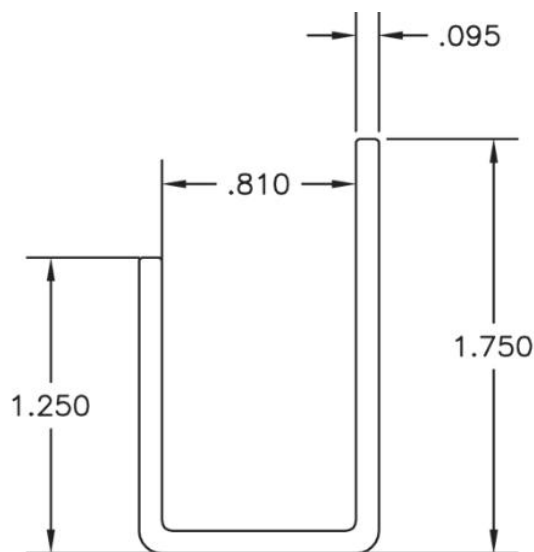

H-277